

2019

STANDARDPROFILE

Standard profiles

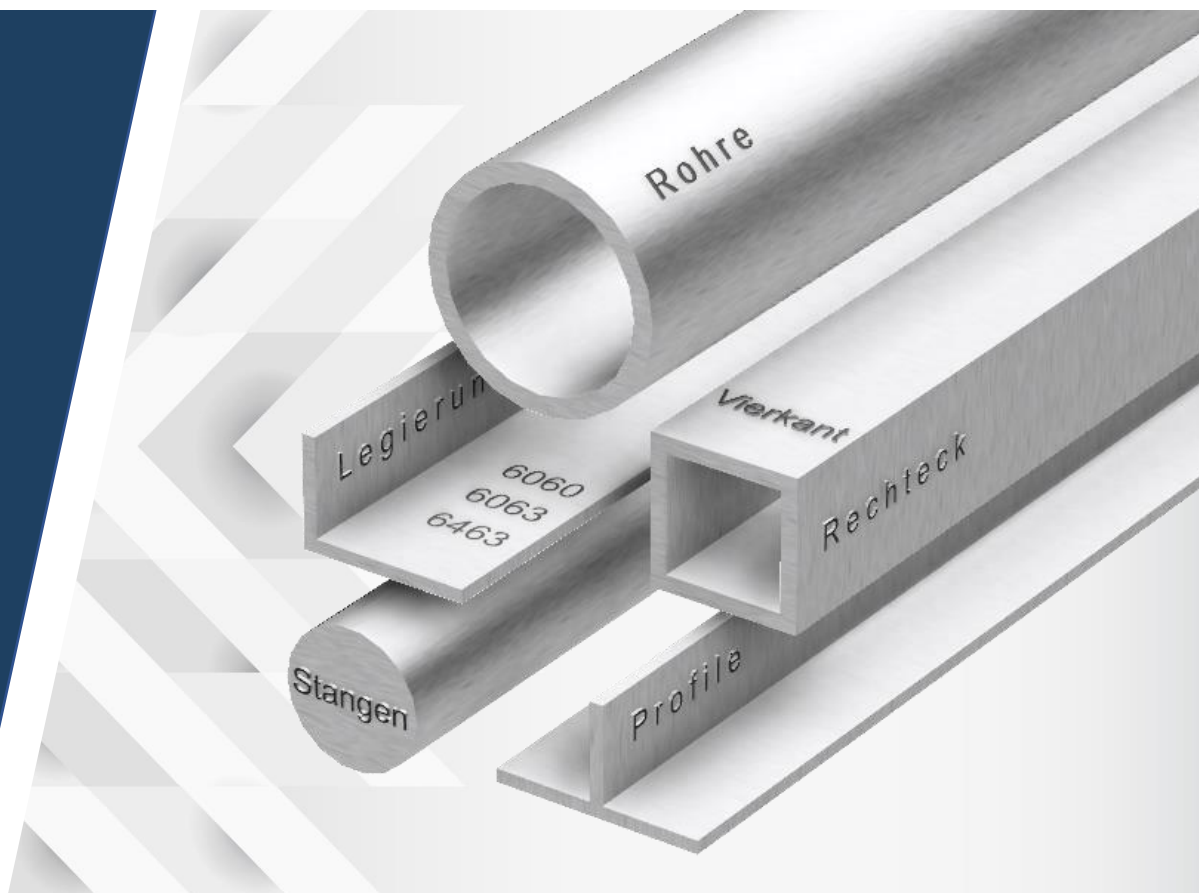

HANDELSPAUL GMBH



VIERKANTROHRE / *Square tubes*

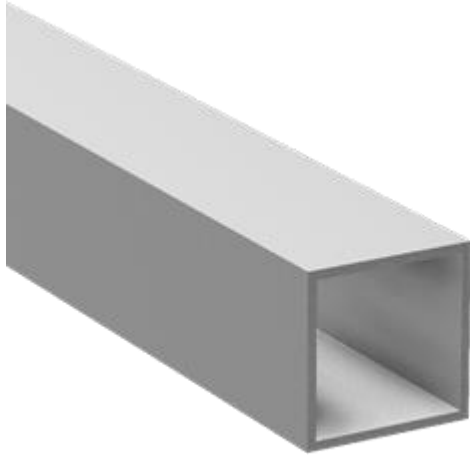

A (mm)	Wandstärke T (mm)
10 - 150	1 - 30

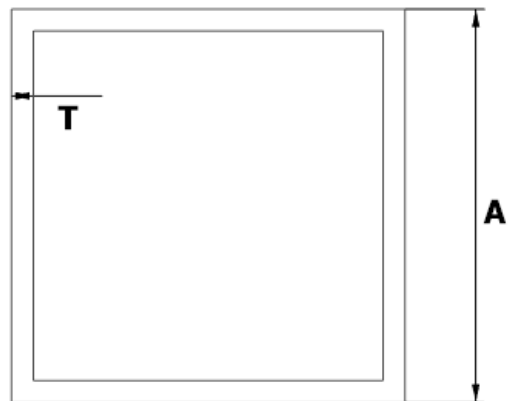

Gerne kontaktieren Sie uns für besondere Abmessungen und weitere Informationen
Please contact us for special dimensions and more information.



RECHTECKROHRE / *Rectangular tubes*

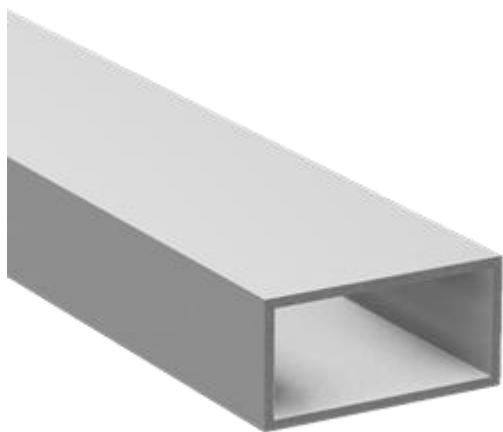

A (mm)	10 - 250
B (mm)	10 - 130
Wandstärke T (mm)	1 - 30

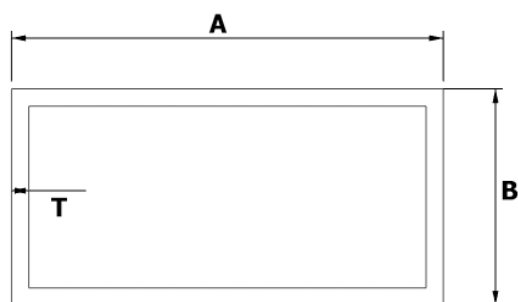

Gerne kontaktieren Sie uns für besondere Abmessungen und weitere Informationen
Please contact us for special dimensions and more information.



RUNDROHRE / *Round tubes*

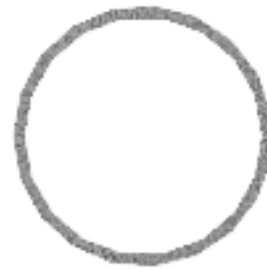

R (mm)	Wandstärke T (mm)
10 - 200	1 - 30

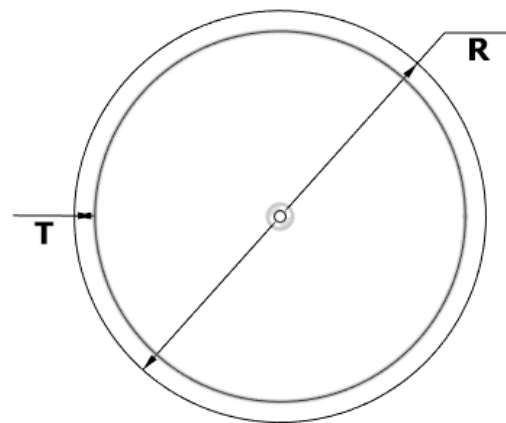

Gerne kontaktieren Sie uns für besondere Abmessungen und weitere Informationen
Please contact us for special dimensions and more information.



FLACHROHRE / *Flat tubes*

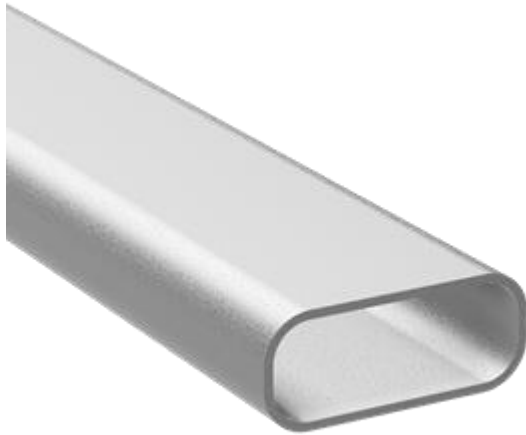

A (mm)	10 - 250
B (mm)	10 - 130
Wandstärke T (mm)	1 - 30

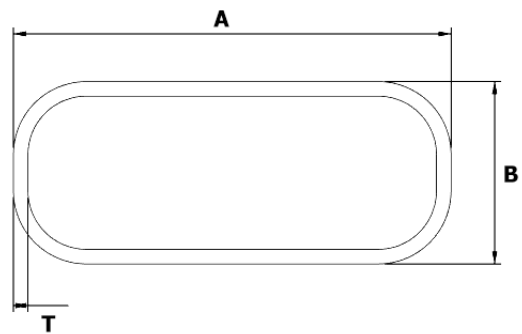

Gerne kontaktieren Sie uns für besondere Abmessungen und weitere Informationen
Please contact us for special dimensions and more information.



SECHSKANTROHRE / *Hexagon tubes*

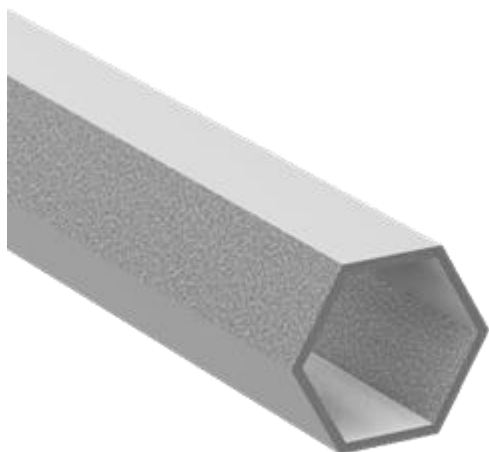

A (mm)	Wandstärke T (mm)
10 - 250	1 - 30

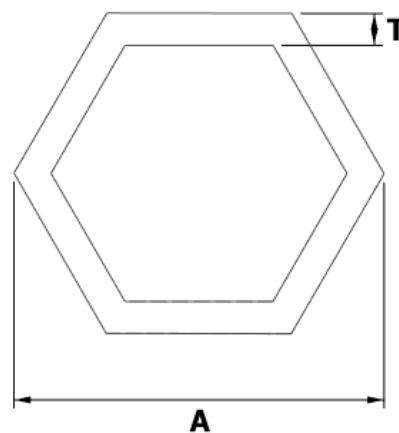

Gerne kontaktieren Sie uns für besondere Abmessungen und weitere Informationen
Please contact us for special dimensions and more information.



VIERKANTSTANGEN / *Square bars*

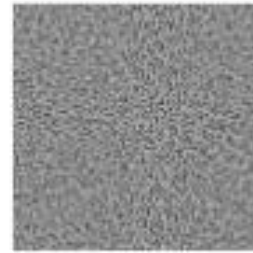
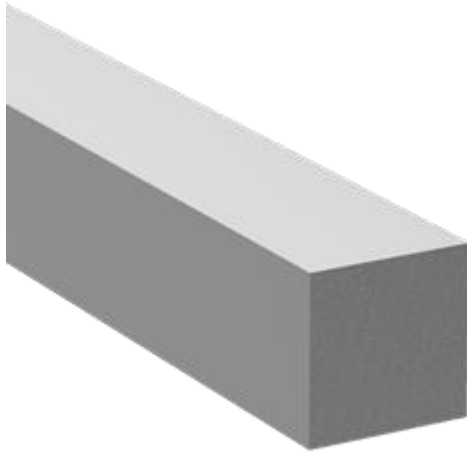

A (mm)
10 - 150



Gerne kontaktieren Sie uns für besondere Abmessungen und weitere Informationen
Please contact us for special dimensions and more information.



RUNDSTANGEN / *Round bars*

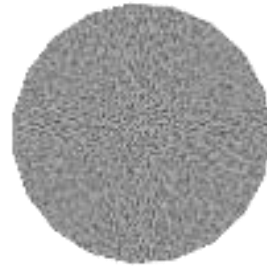
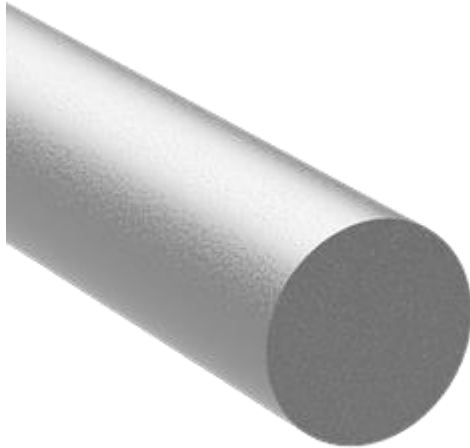

R (mm)
10 - 200

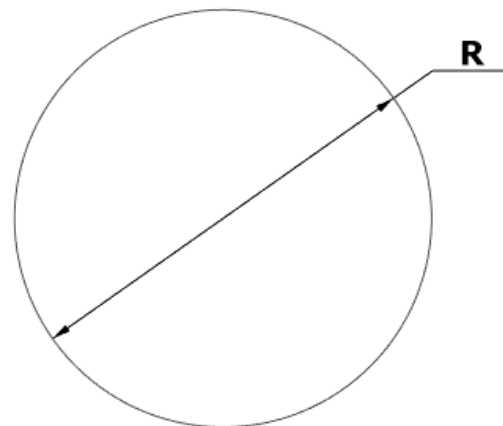

Gerne kontaktieren Sie uns für besondere Abmessungen und weitere Informationen
Please contact us for special dimensions and more information.



FLACHSTANGEN / *Flat bars*

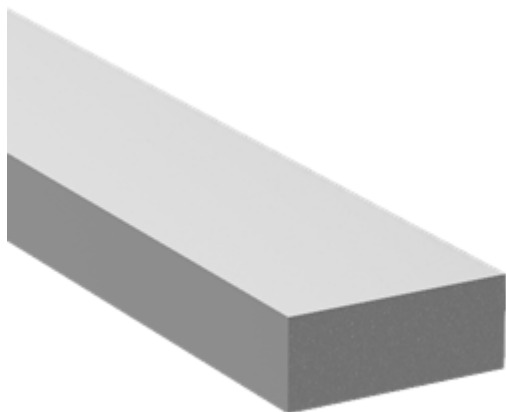

A (mm)	B (mm)
10 - 250	10 - 130

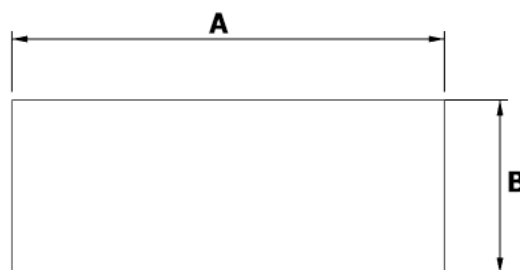

Gerne kontaktieren Sie uns für besondere Abmessungen und weitere Informationen
Please contact us for special dimensions and more information.



SECHSKANTSTANGEN / *Hexagon bars*

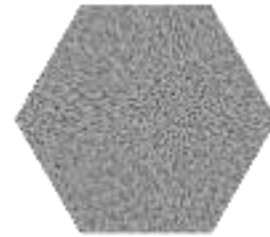
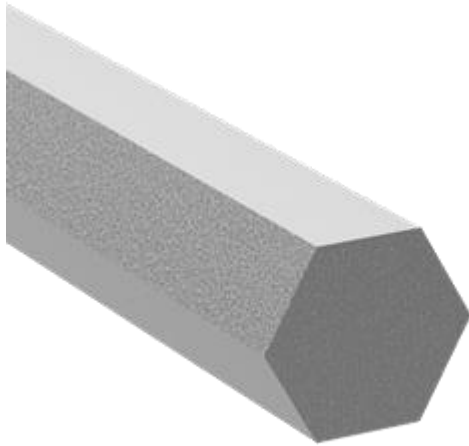

A (mm)

10 - 200

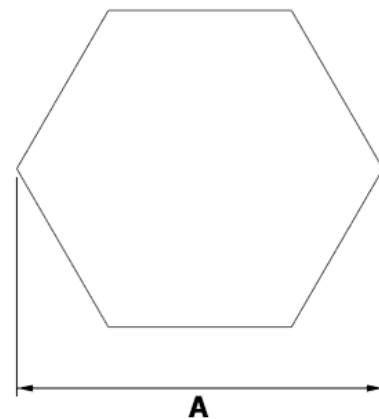

Gerne kontaktieren Sie uns für besondere Abmessungen und weitere Informationen
Please contact us for special dimensions and more information.



FLACHOVALE / *Flat ovals*

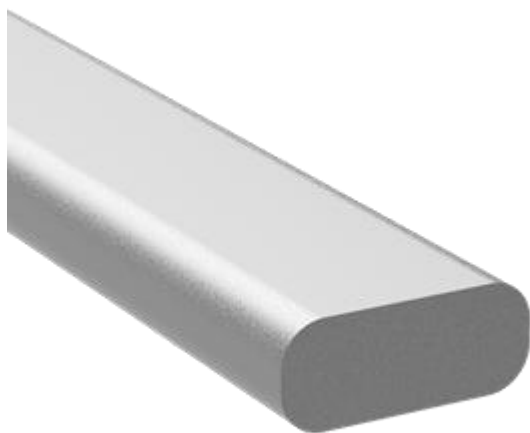

A (mm)	B (mm)
10 - 250	0,8 - 130

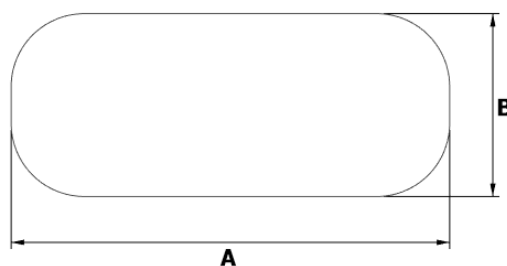

Gerne kontaktieren Sie uns für besondere Abmessungen und weitere Informationen
Please contact us for special dimensions and more information.



T-PROFILE / *T-Profiles*

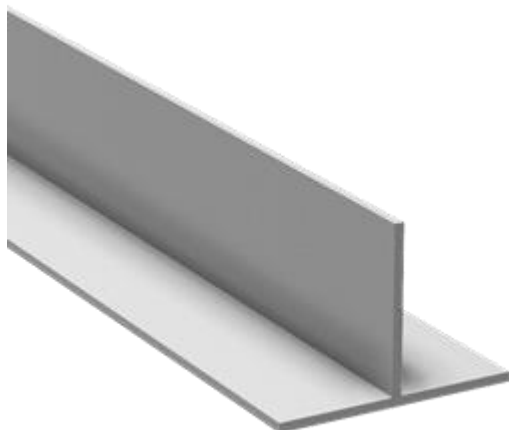

A (mm)	10 - 250
B (mm)	10 - 130
Wandstärke (mm)	1 - 30

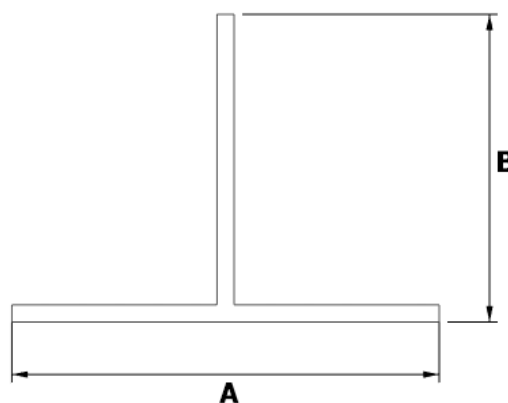

Gerne kontaktieren Sie uns für besondere Abmessungen und weitere Informationen
Please contact us for special dimensions and more information.



U-PROFILE / *U-Profiles*

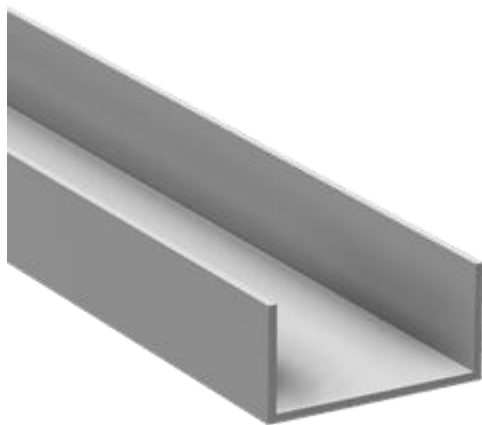

A (mm)	10 - 250
B (mm)	10 - 130
Wandstärke T (mm)	1 - 30

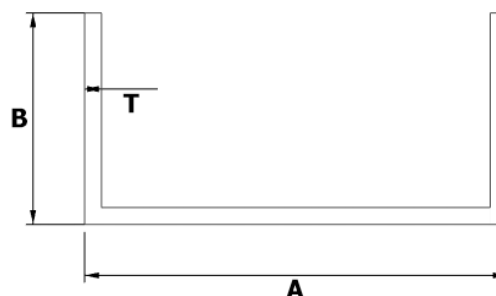

Gerne kontaktieren Sie uns für besondere Abmessungen und weitere Informationen
Please contact us for special dimensions and more information.



Z-PROFILE / *Z-Profiles*

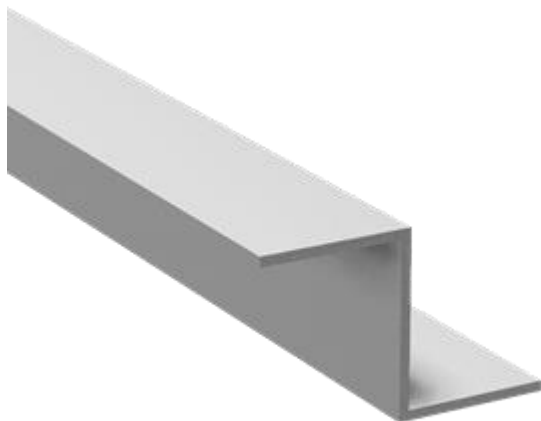

A (mm)	10 - 250
B (mm)	15 - 250
C (mm)	15 - 140
Wandstärke T (mm)	1 - 30

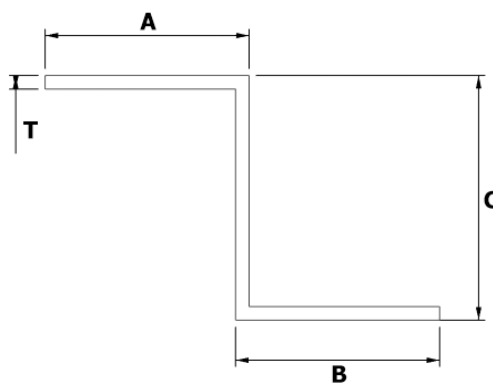

Gerne kontaktieren Sie uns für besondere Abmessungen und weitere Informationen
Please contact us for special dimensions and more information.



GLEICHSCHENKLIGE WINKEL / *Equal angles*

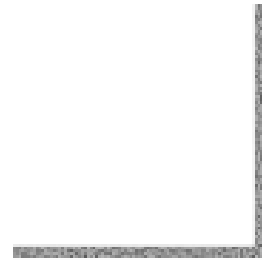
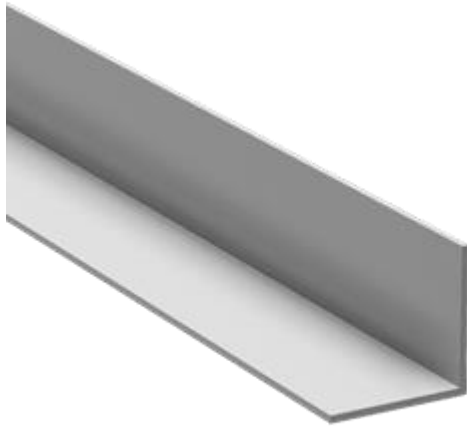

A (mm)	Wandstärke T (mm)
10 - 150	1 - 30

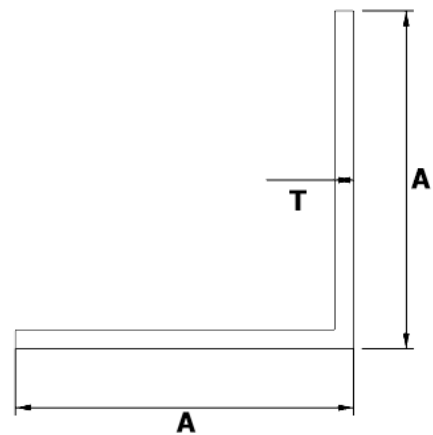

Gerne kontaktieren Sie uns für besondere Abmessungen und weitere Informationen
Please contact us for special dimensions and more information.



UNGLEICHSCHENKLIGE WINKEL / *Unequal angles*

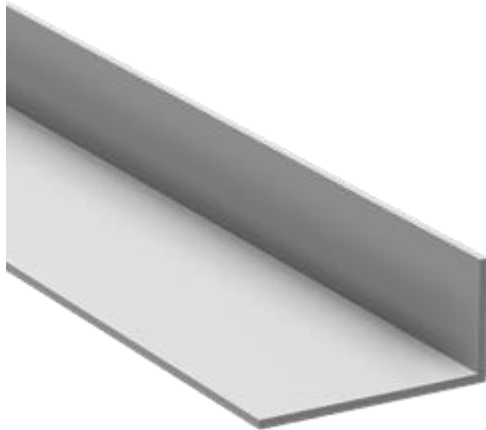

A (mm)	10 - 250
B (mm)	10 - 130
Wandstärke T (mm)	1 - 30

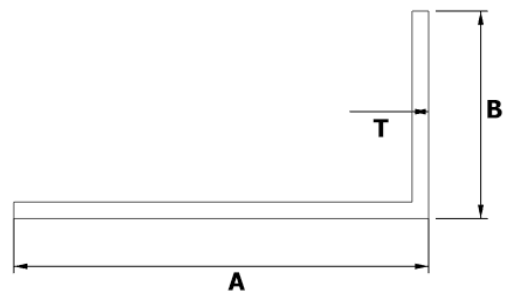

Gerne kontaktieren Sie uns für besondere Abmessungen und weitere Informationen
Please contact us for special dimensions and more information.



SONDERPROFIL 01 / *Special tubes 01*



A (mm)	B (mm)
auf Anfrage <i>on request</i>	

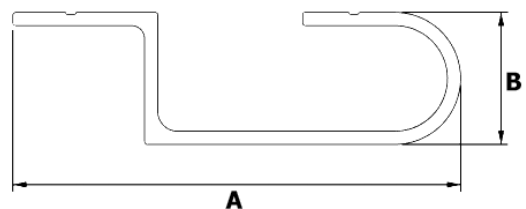

Gerne kontaktieren Sie uns für besondere Abmessungen und weitere Informationen
Please contact us for special dimensions and more information.



SONDERPROFIL 02 / *Special tubes 02*

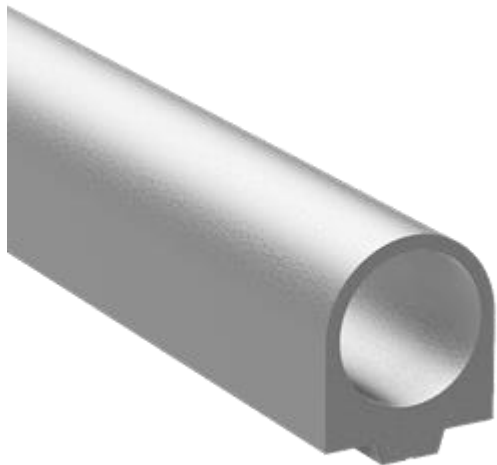

A (mm)	auf Anfrage <i>on request</i>
B (mm)	
R (mm)	

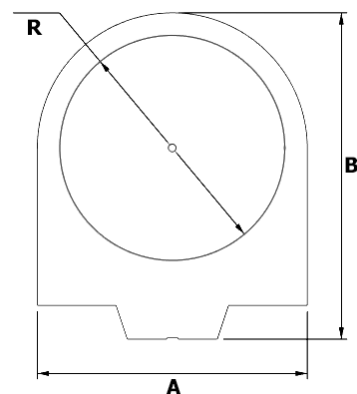

Gerne kontaktieren Sie uns für besondere Abmessungen und weitere Informationen
Please contact us for special dimensions and more information.



SONDERPROFIL 03 / *Special tubes 03*



A (mm)	
B (mm)	auf Anfrage
C (mm)	on request
T (mm)	

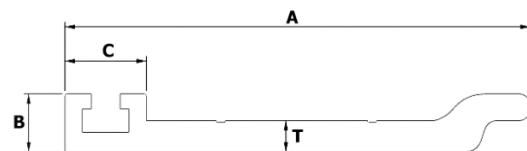

Gerne kontaktieren Sie uns für besondere Abmessungen und weitere Informationen
Please contact us for special dimensions and more information.



SONDERPROFIL 04 / *Special tubes 04*



A (mm)	B (mm)
auf Anfrage <i>on request</i>	

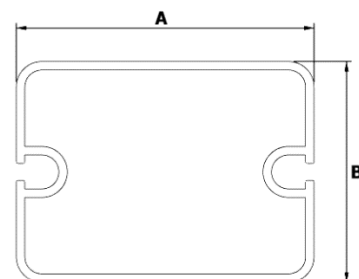

Gerne kontaktieren Sie uns für besondere Abmessungen und weitere Informationen
Please contact us for special dimensions and more information.



SONDERPROFIL 05 / *Special tubes 05*



A (mm)	auf Anfrage <i>on request</i>
B (mm)	
C (mm)	

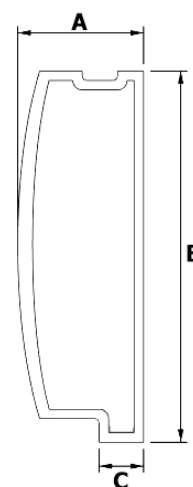

Gerne kontaktieren Sie uns für besondere Abmessungen und weitere Informationen
Please contact us for special dimensions and more information.



SONDERPROFIL 06 / *Special tubes 06*



A (mm)	auf Anfrage <i>on request</i>
B (mm)	
C (mm)	
D (mm)	

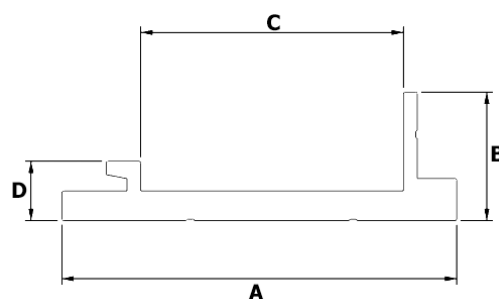

Gerne kontaktieren Sie uns für besondere Abmessungen und weitere Informationen
Please contact us for special dimensions and more information.



SONDERPROFIL 07 / *Special tubes 07*

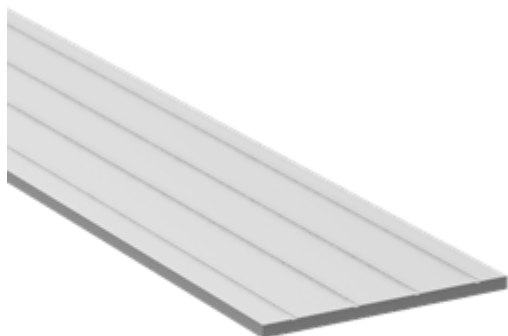

A (mm)	T (mm)
auf Anfrage <i>on request</i>	

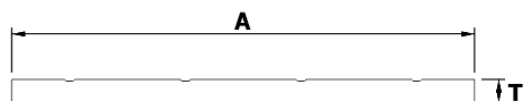

Gerne kontaktieren Sie uns für besondere Abmessungen und weitere Informationen
Please contact us for special dimensions and more information.



SONDERPROFIL 08 / *Special tubes 08*

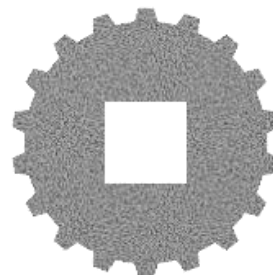

R (mm)

auf Anfrage
on request

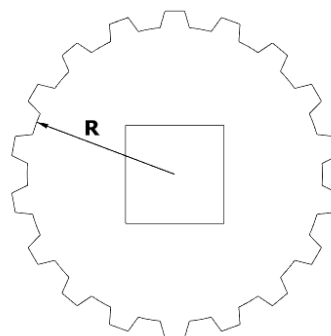

Gerne kontaktieren Sie uns für besondere Abmessungen und weitere Informationen
Please contact us for special dimensions and more information.



SONDERPROFIL 09 / *Special tubes 09*

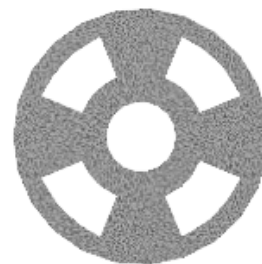

R (mm)
auf Anfrage <i>on request</i>

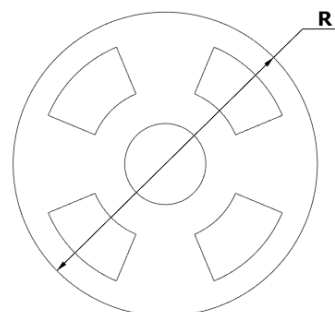

Gerne kontaktieren Sie uns für besondere Abmessungen und weitere Informationen
Please contact us for special dimensions and more information.



SONDERPROFIL 10 / *Special tubes 10*

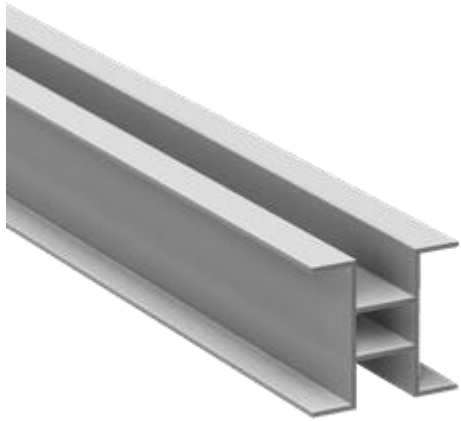

A (mm)	B (mm)
auf Anfrage <i>on request</i>	

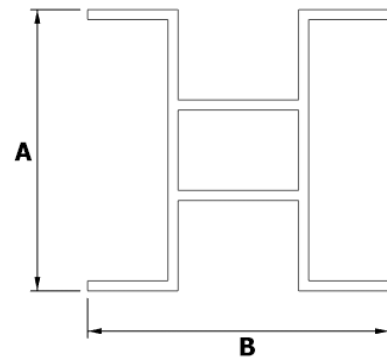

Gerne kontaktieren Sie uns für besondere Abmessungen und weitere Informationen
Please contact us for special dimensions and more information.



SONDERPROFIL 11 / *Special tubes 11*

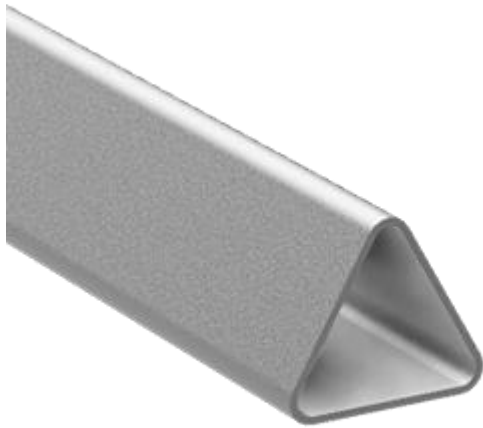

A (mm)	auf Anfrage <i>on request</i>
B (mm)	
C (mm)	

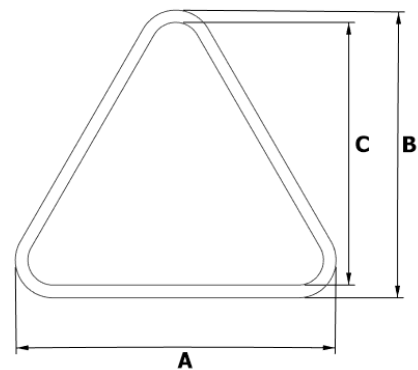

Gerne kontaktieren Sie uns für besondere Abmessungen und weitere Informationen
Please contact us for special dimensions and more information.